

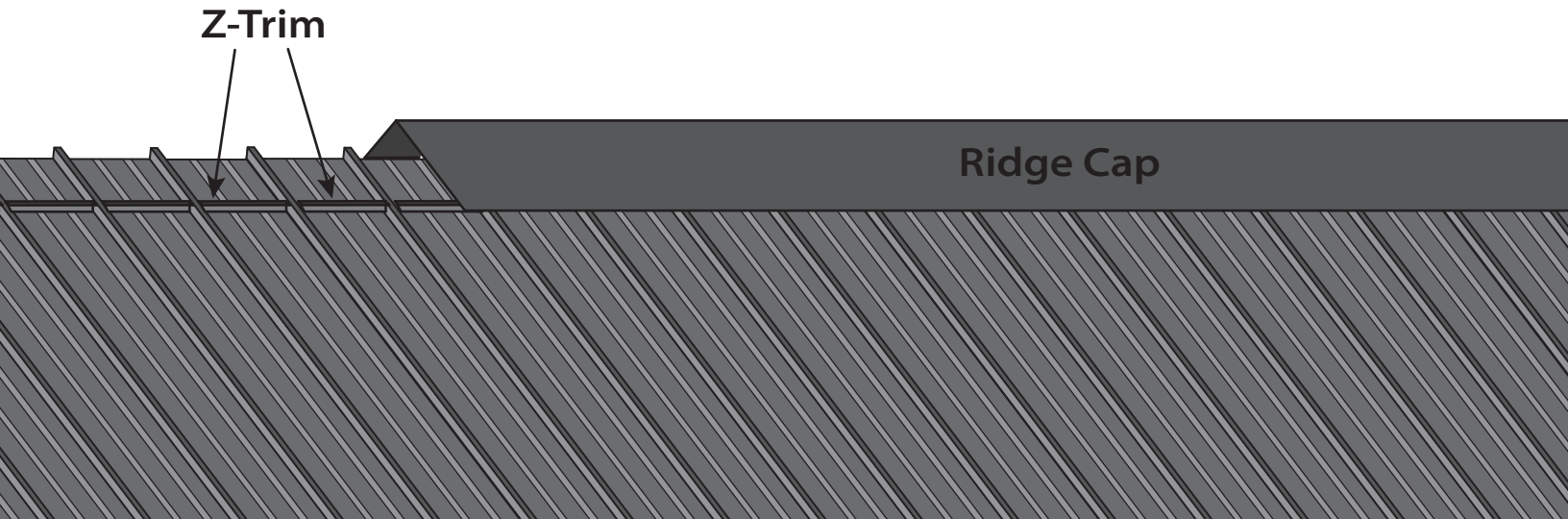

INSTALLATION GUIDE

STANDING SEAM

Standing Seam Ridge Cap Detail

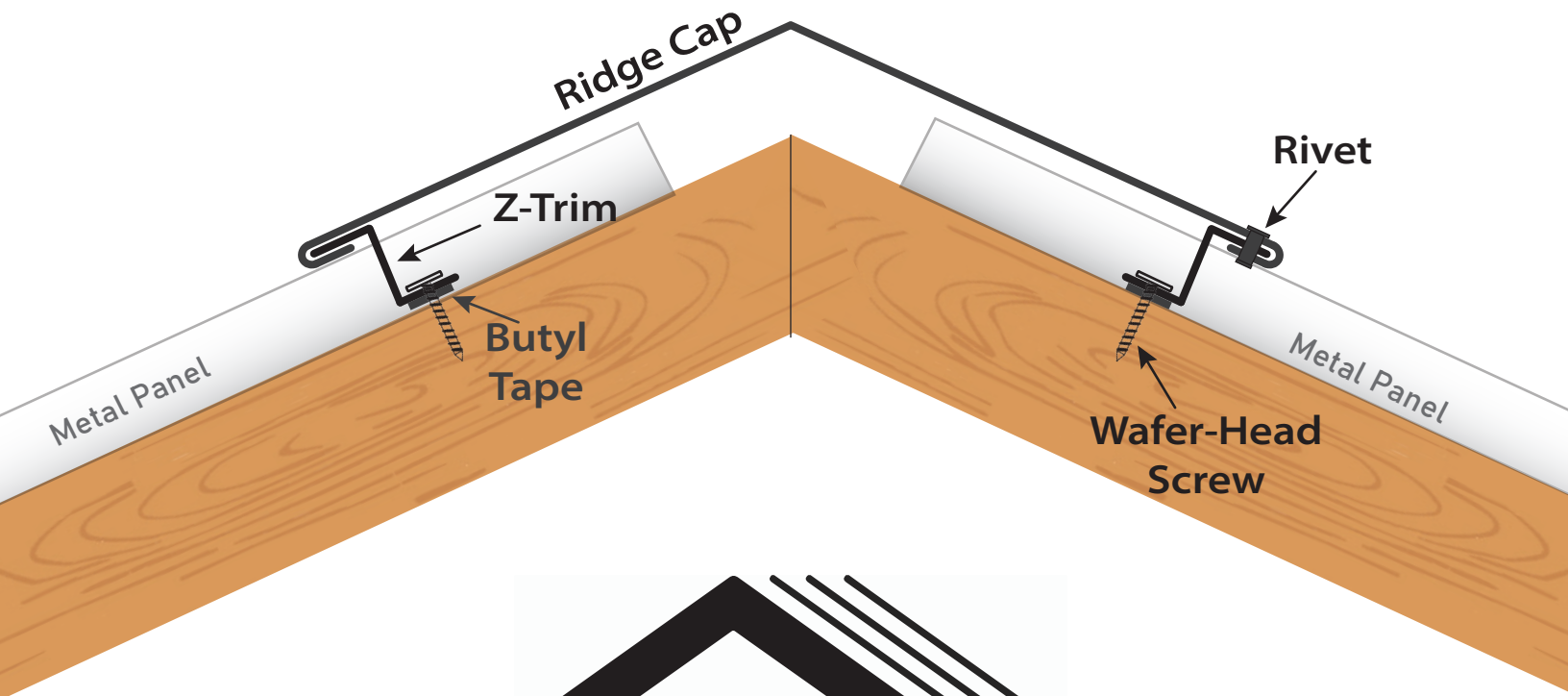

Standing Seam Rake Detail

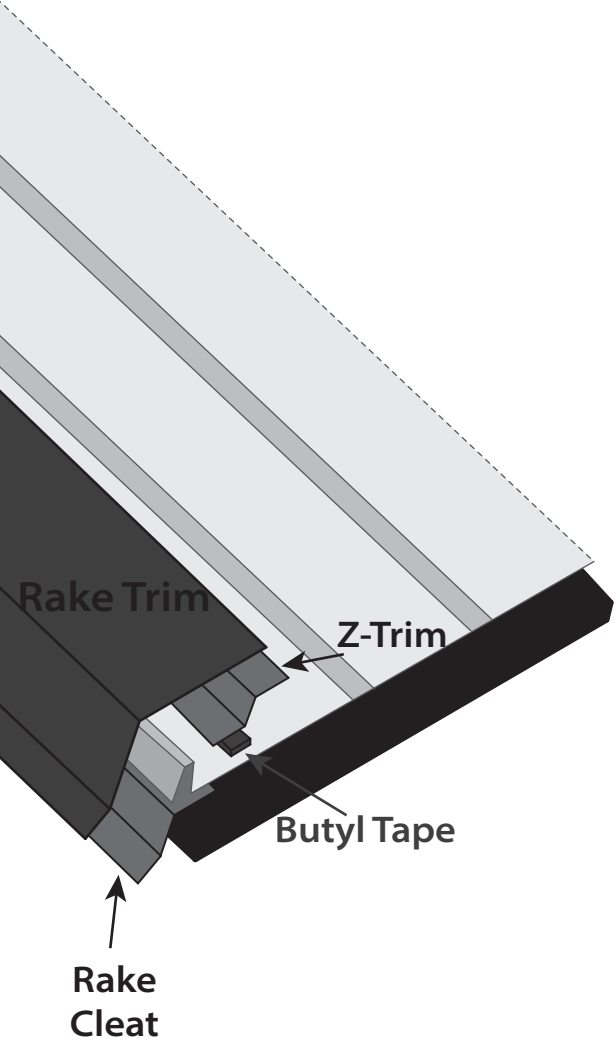

Standing Seam Rake Trim

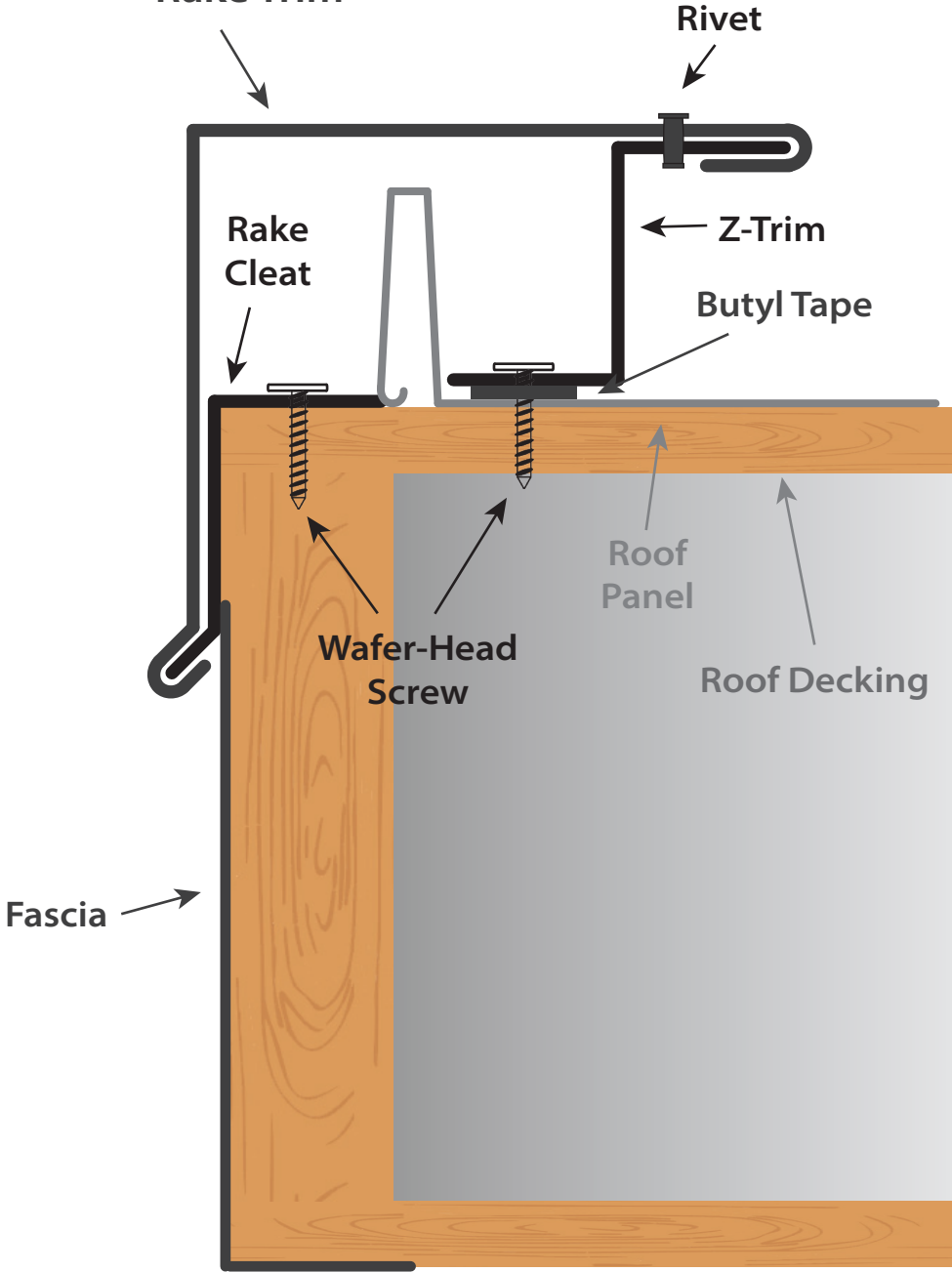

Fascia / Soffit Detail

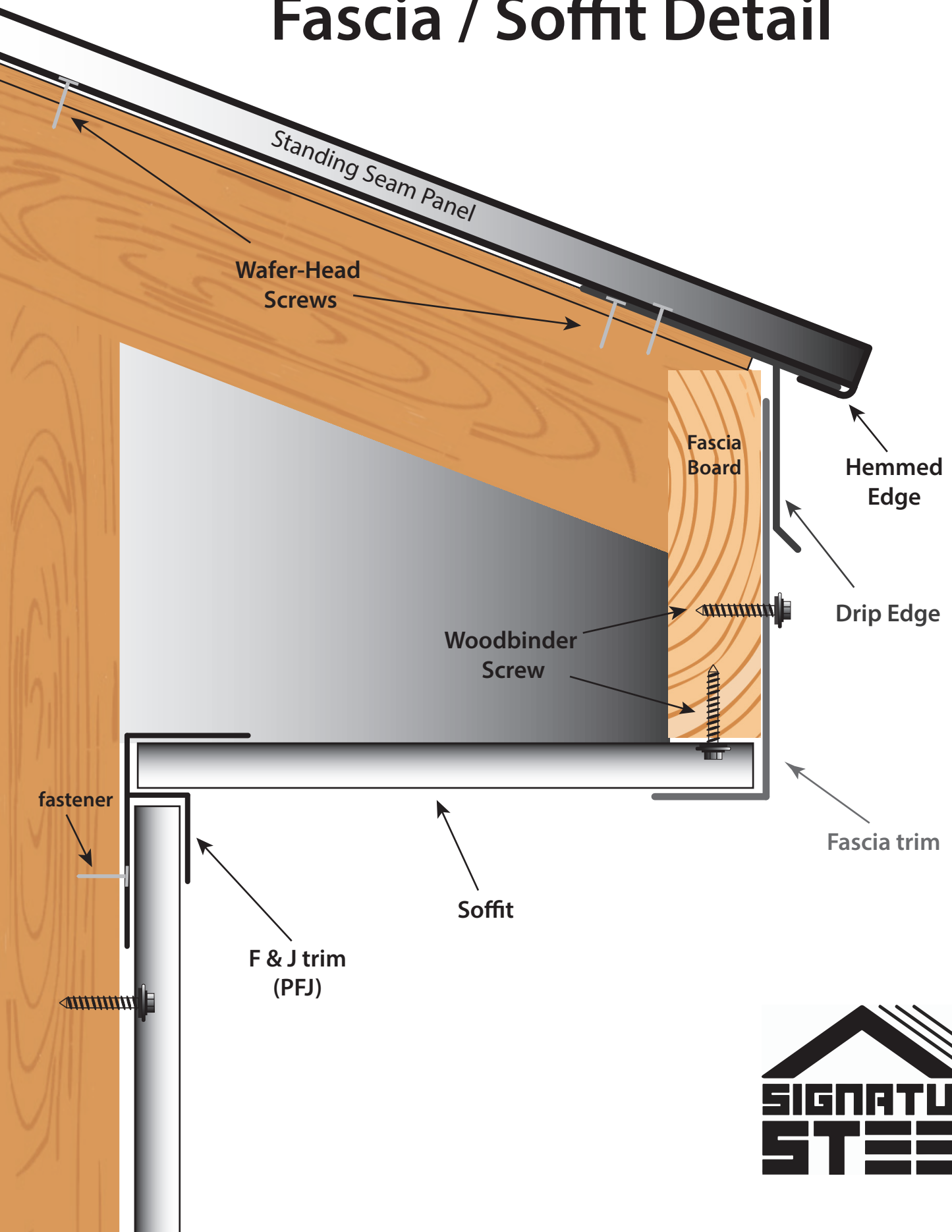

Standing Seam One-Slope Cap

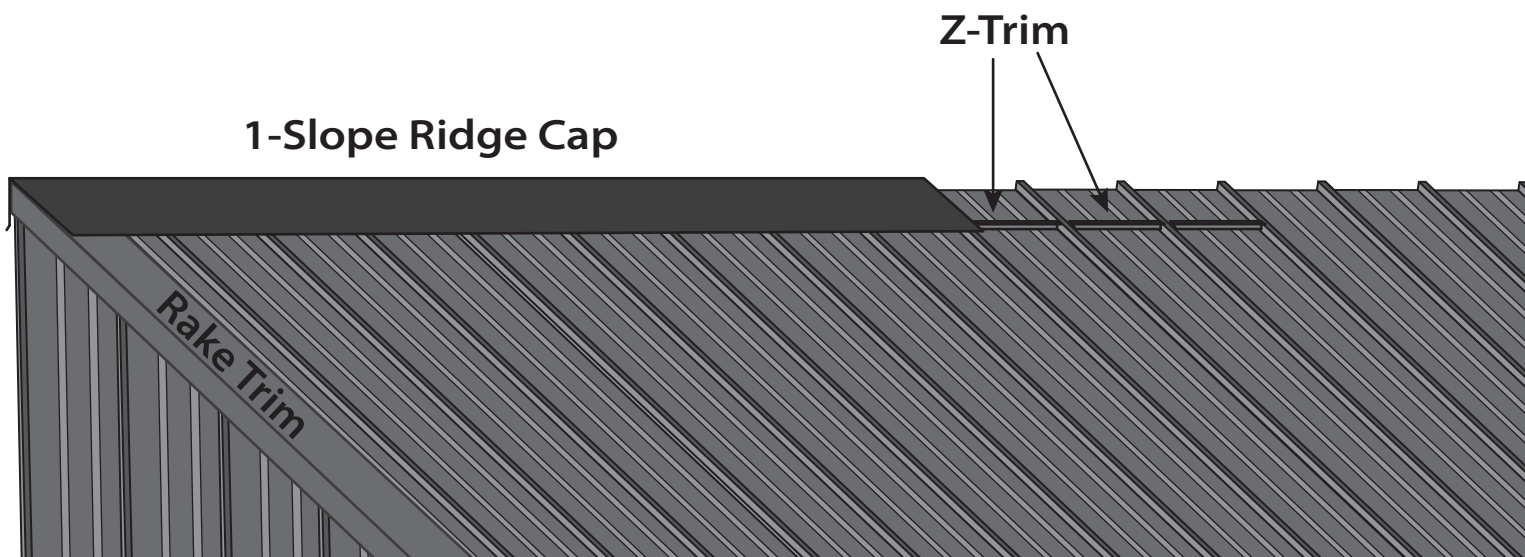
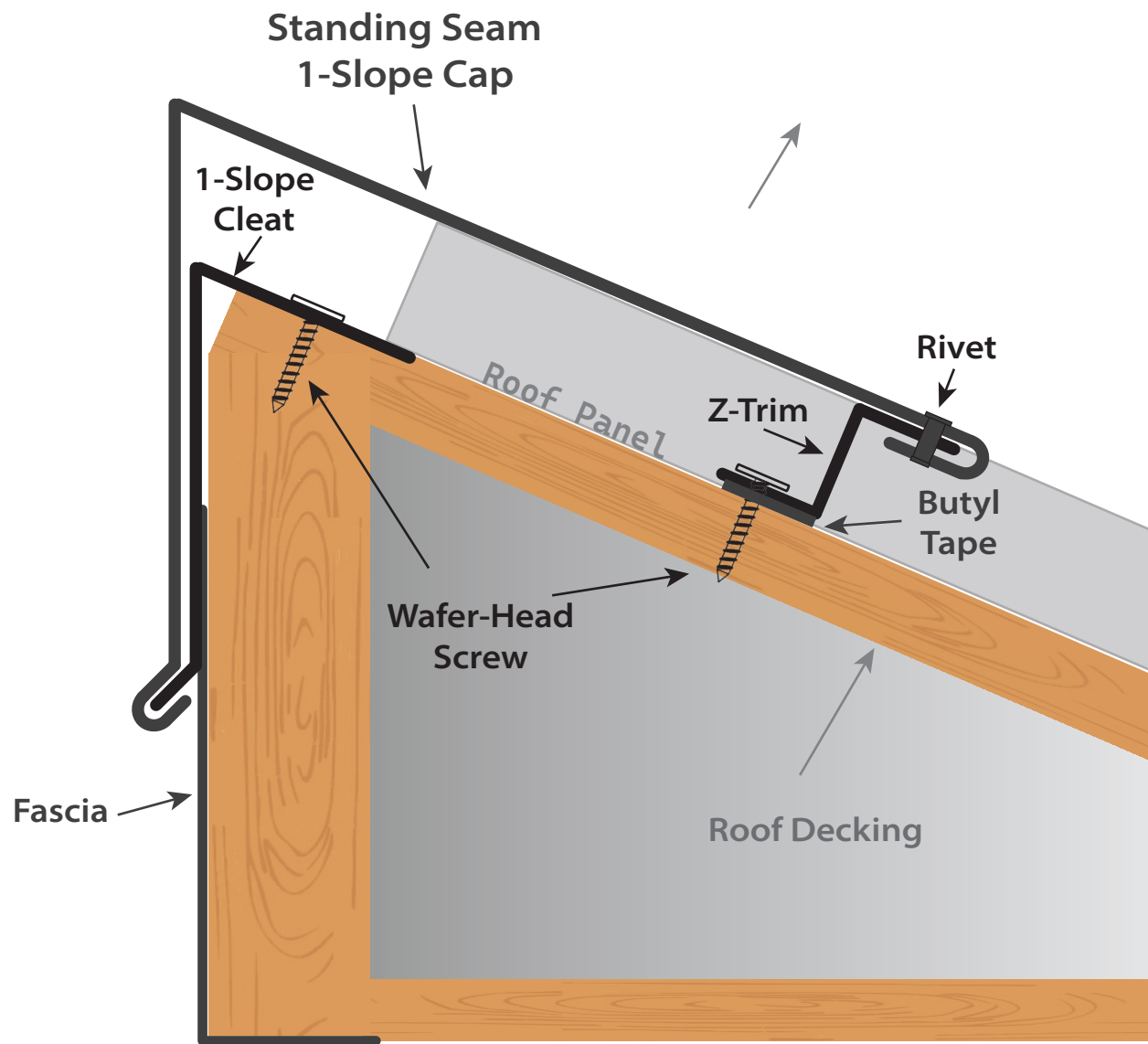



Standing Seam Endwall Flashing Detail

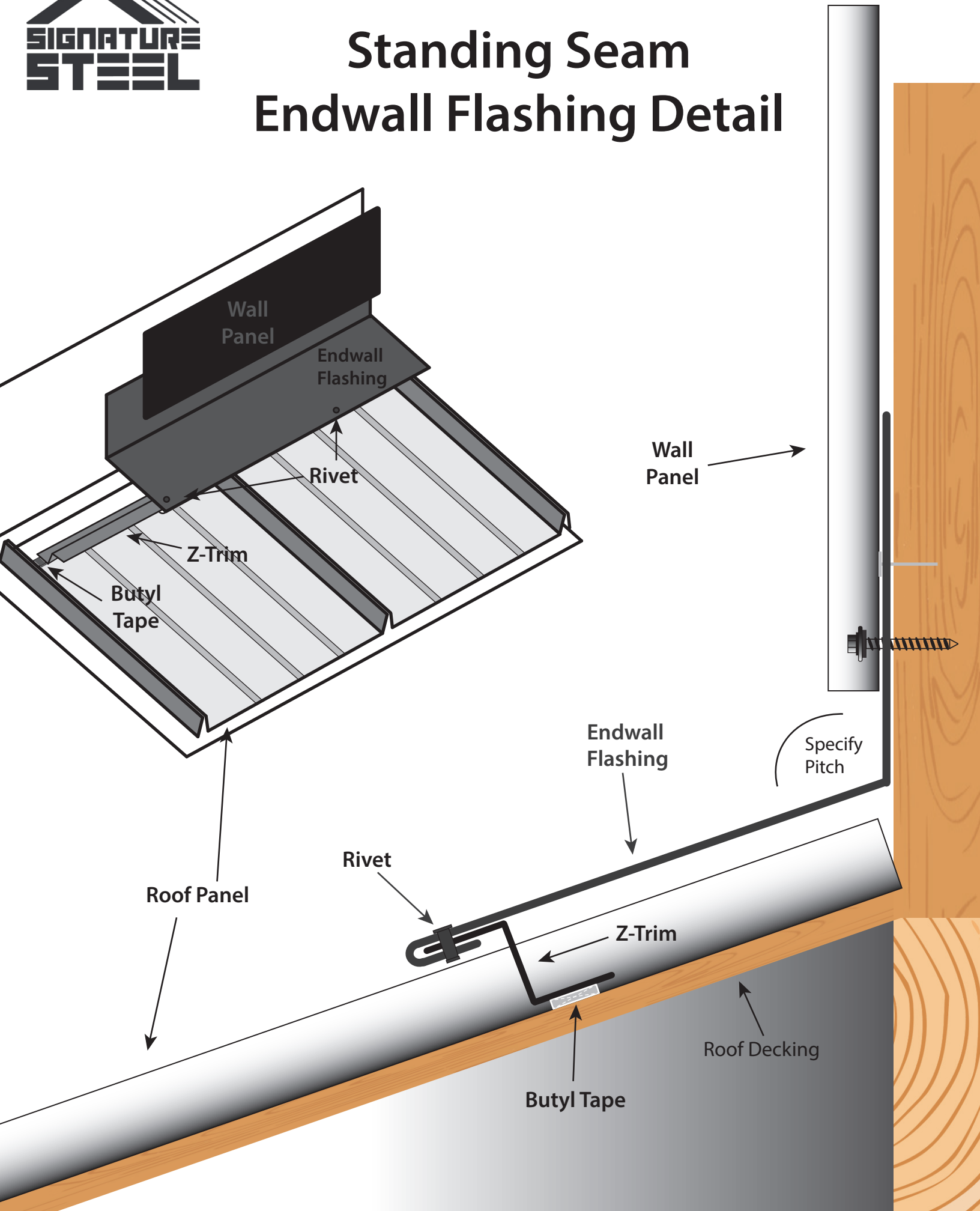

Standing Seam Sidewall Flashing Detail

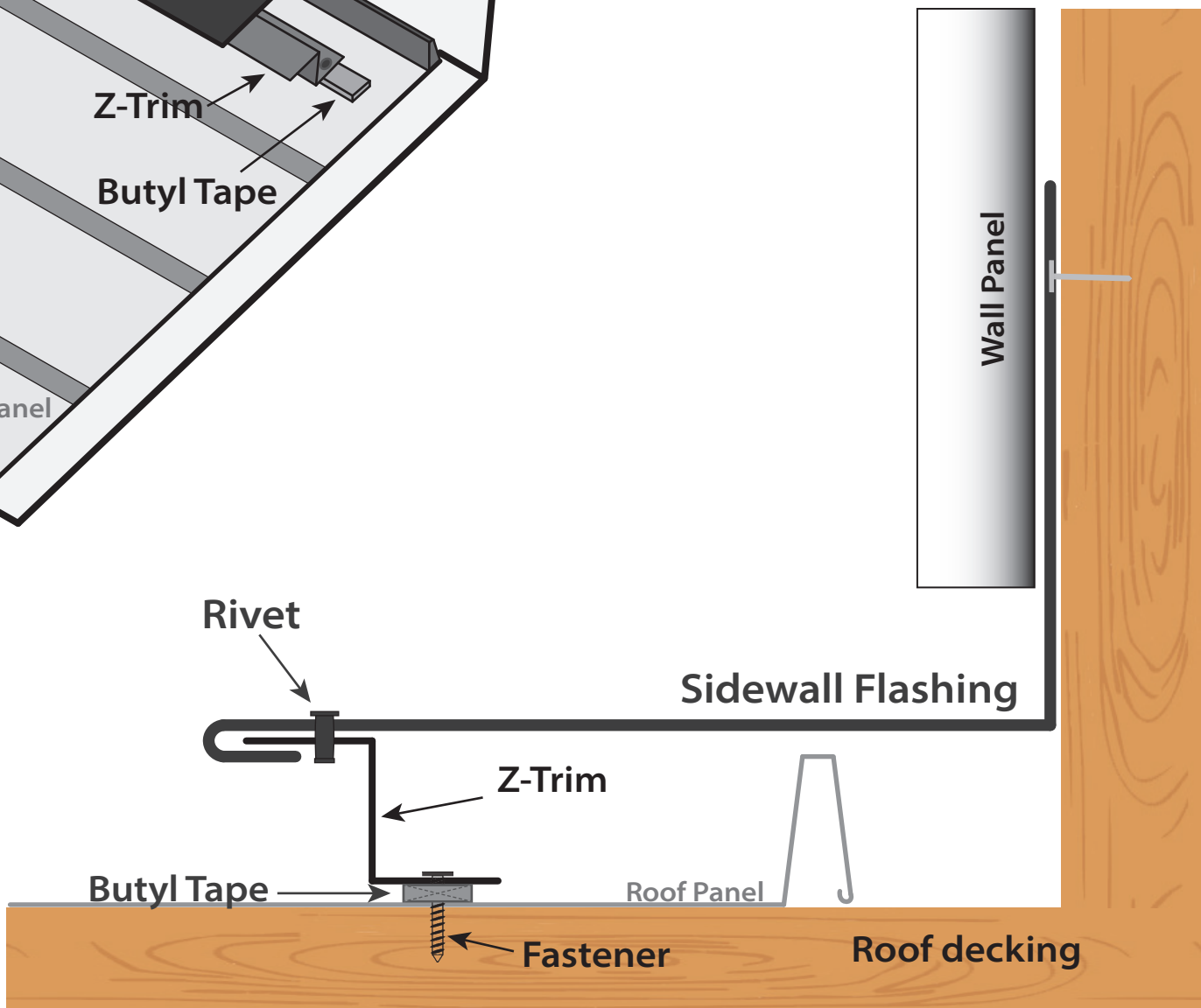
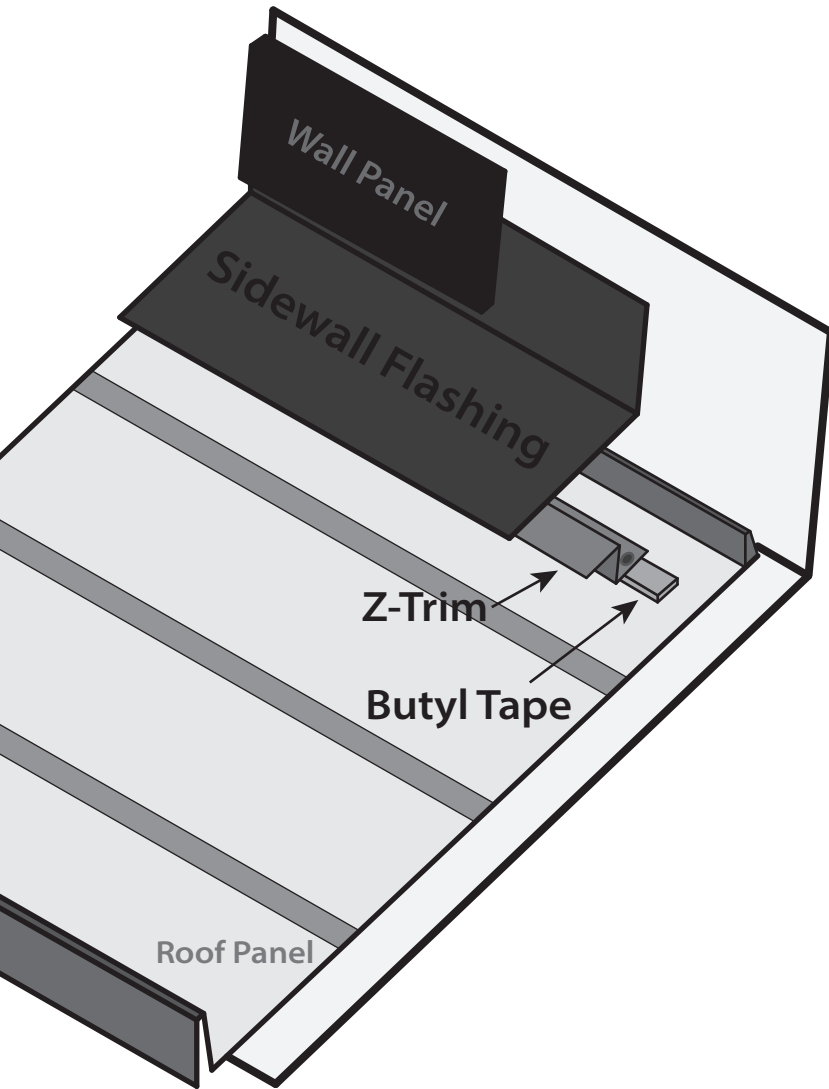

Standing Seam Transition Trim Detail

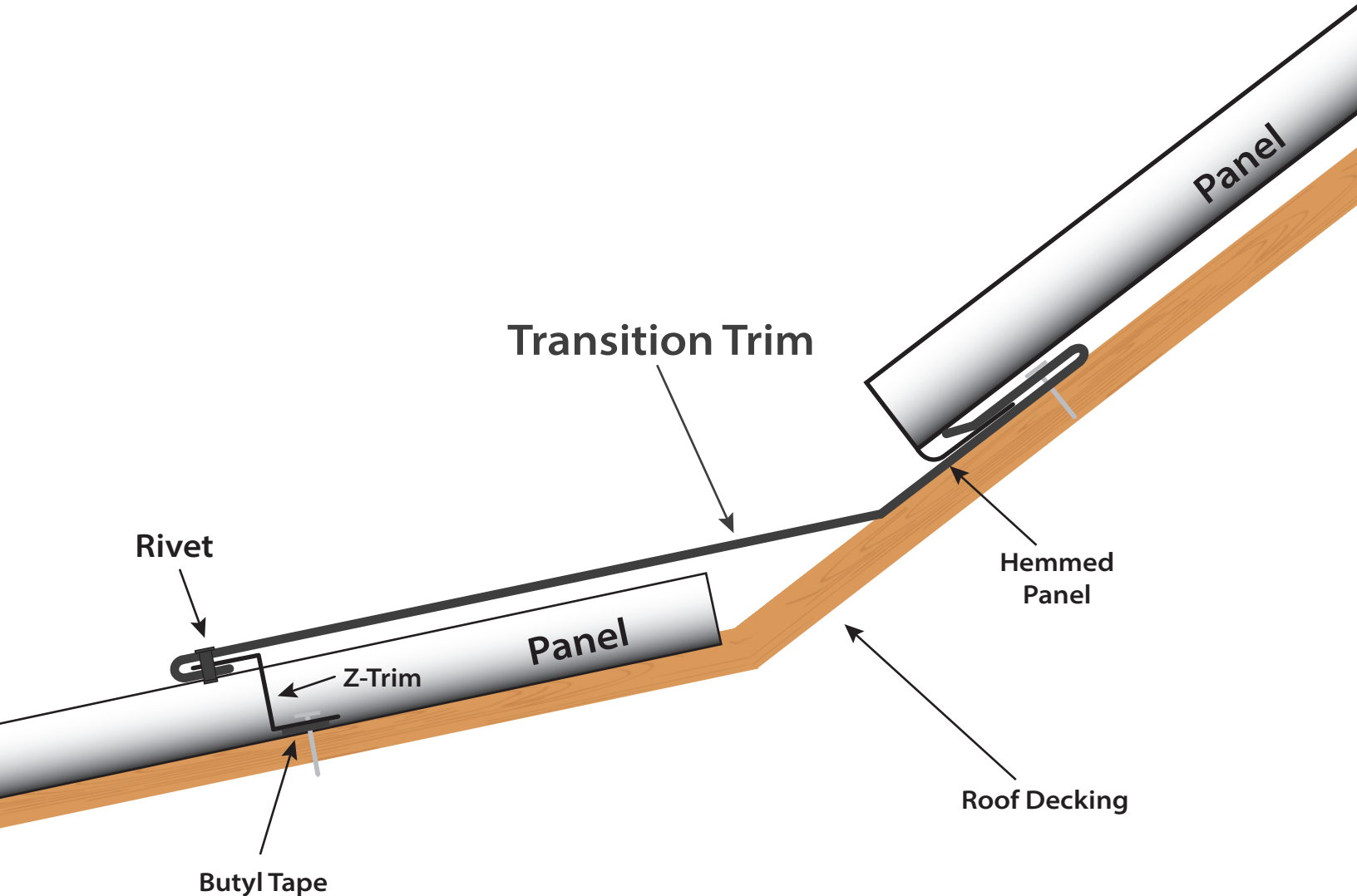

Standing Seam Valley Trim Detail

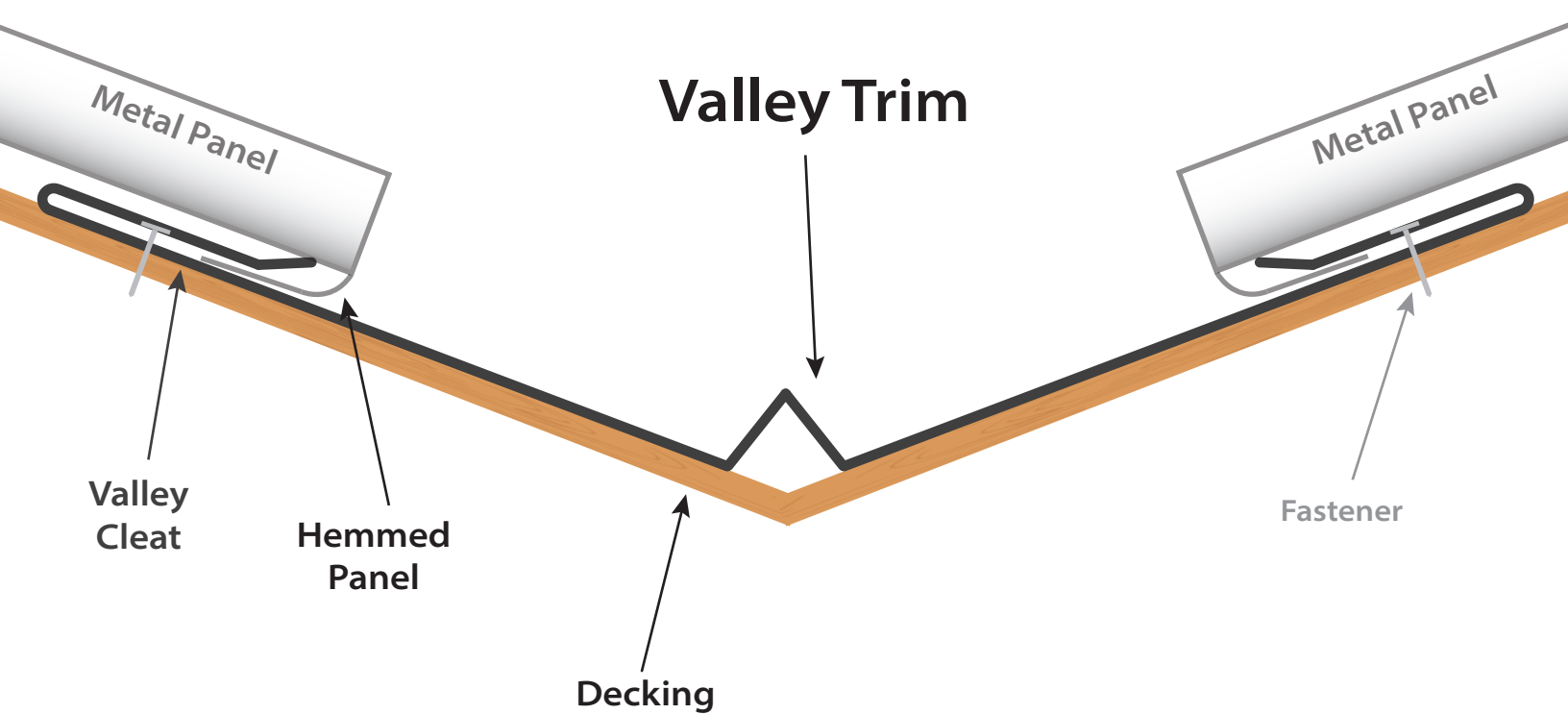

Standing Seam Valley Trim

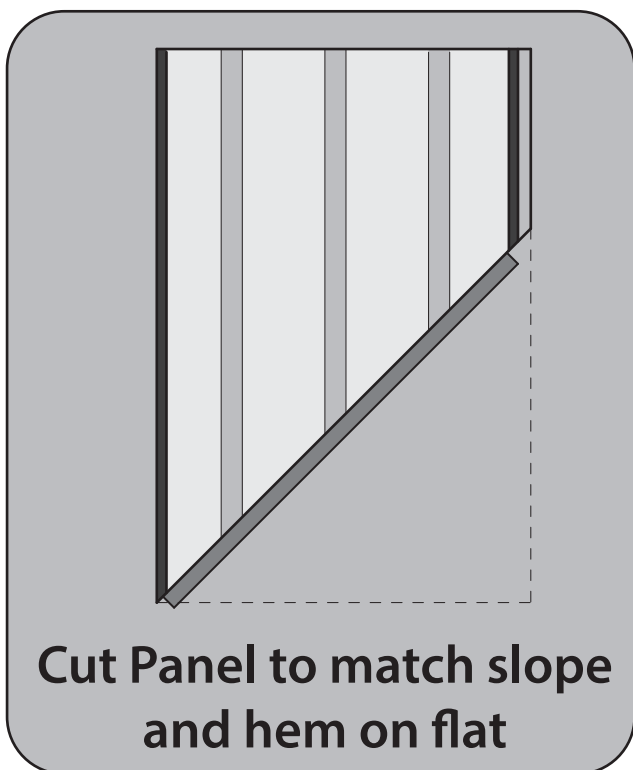
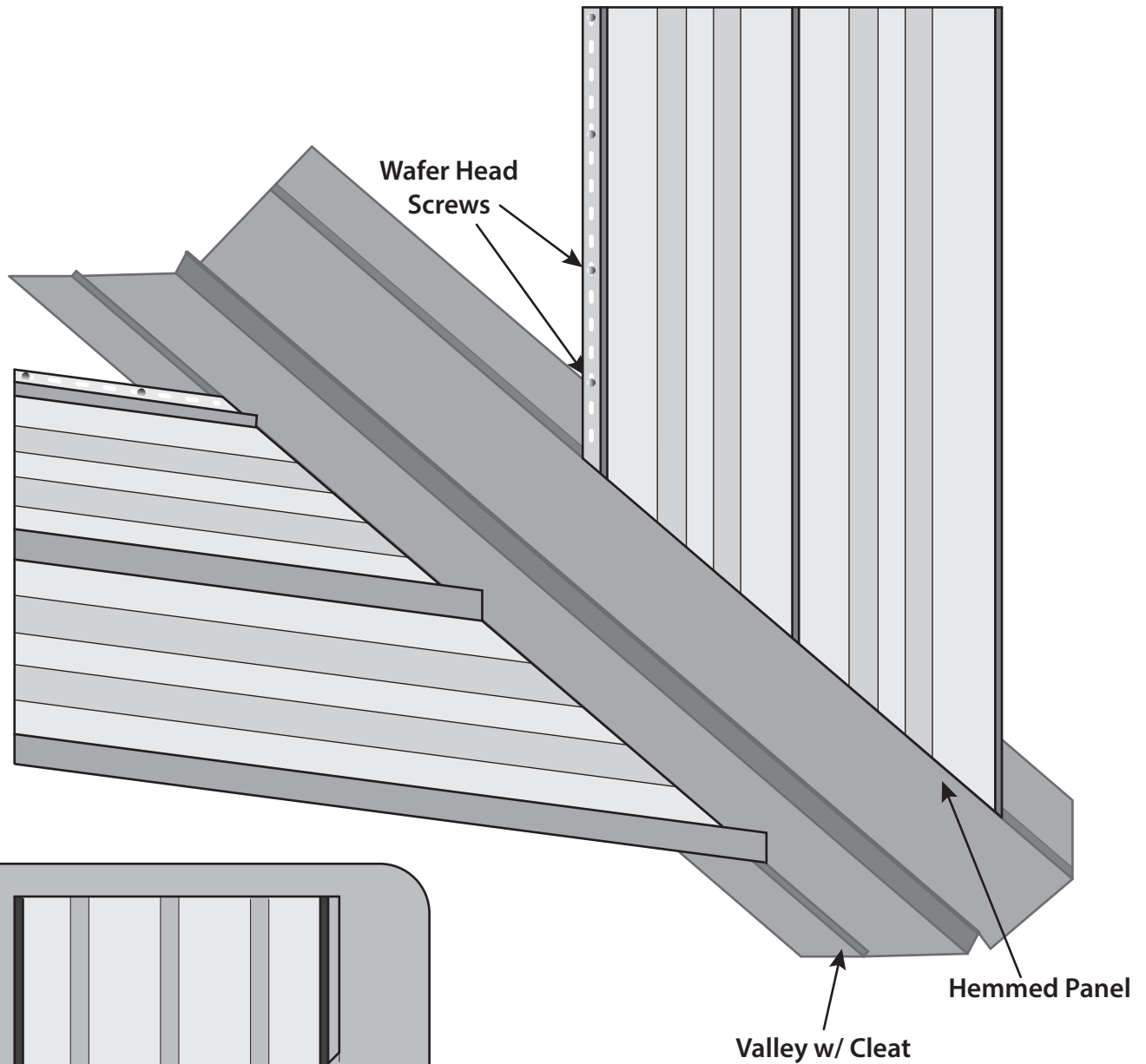

Hemming Details

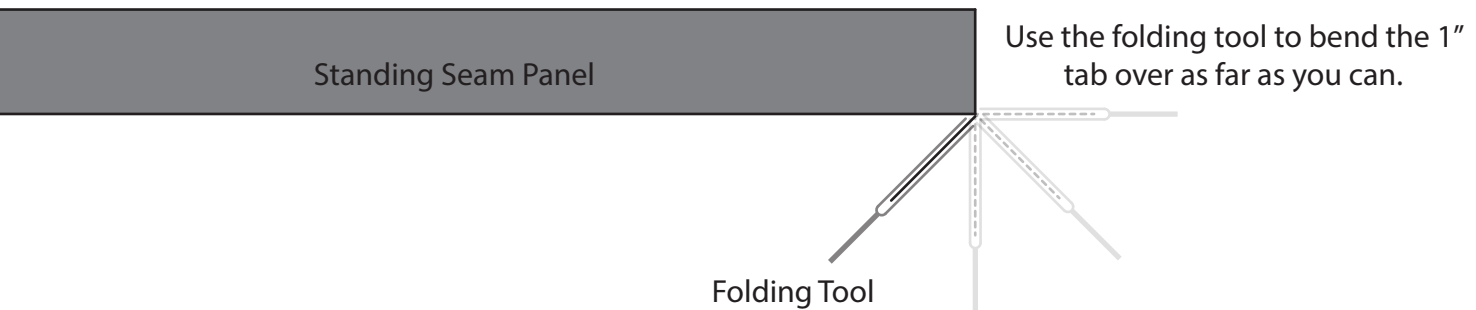
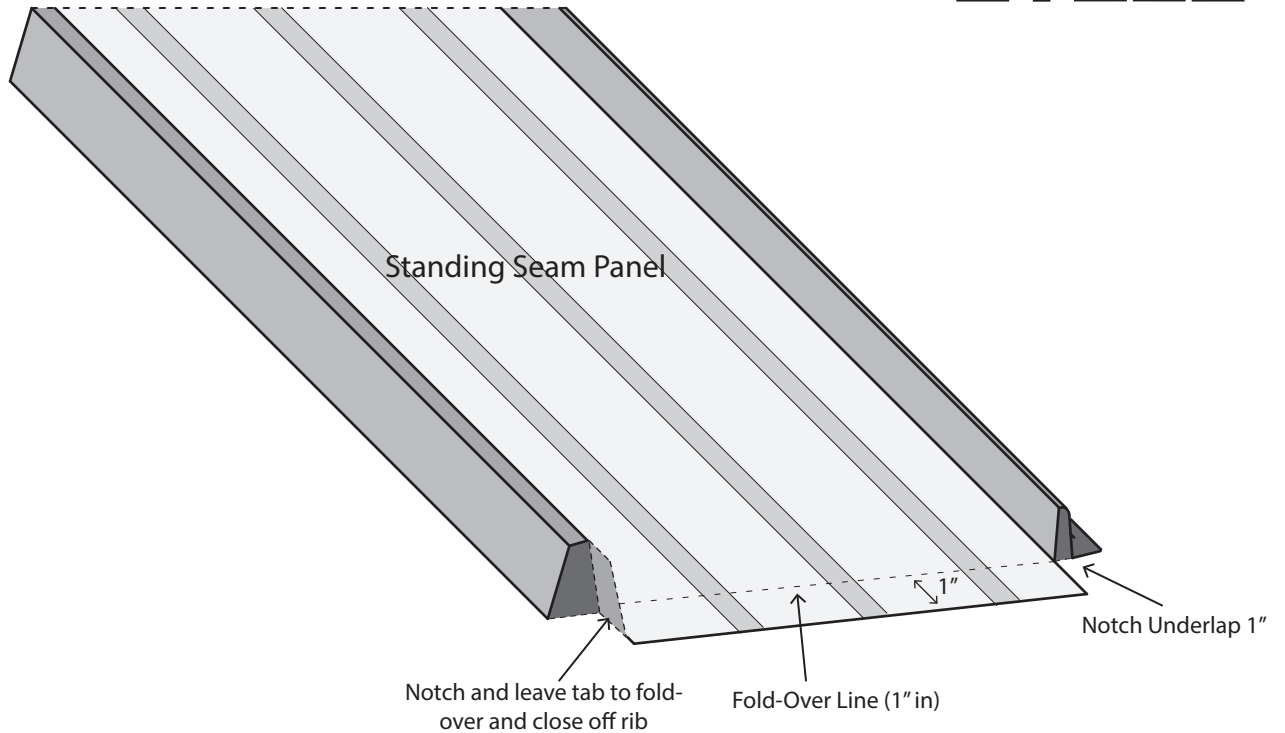

Slide the panel onto the roof, clipping it onto the previous panel and all the way up against the drip edge.

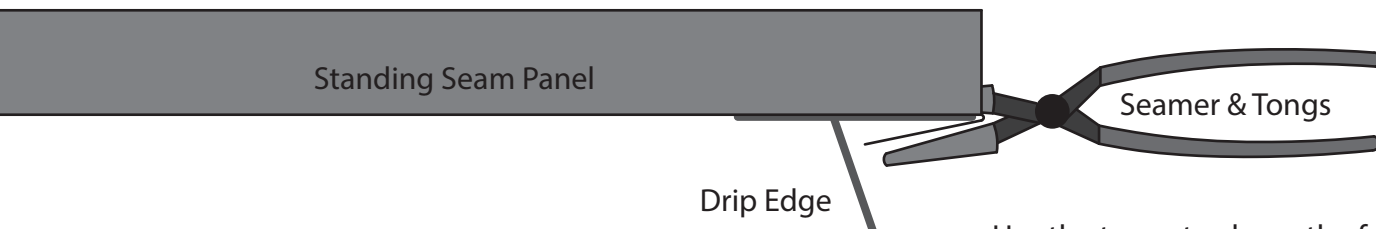

Use the tongs to clamp the folded over hem tightly to the drip edge.
Fold over the extra tab on the rib, trimming with a snips to ensure an exact fit.

Standing Seam Trims



Ridge Cap (SSRCP)



One-Slope Ridge Cap (SS1RCP)

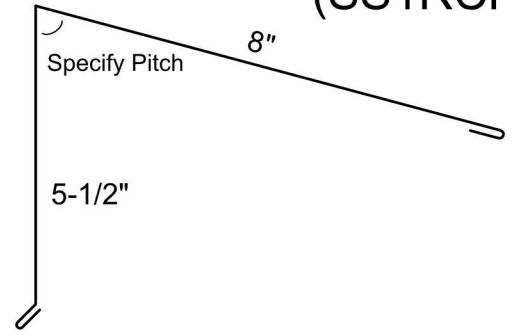

Rake Trim (SSR)

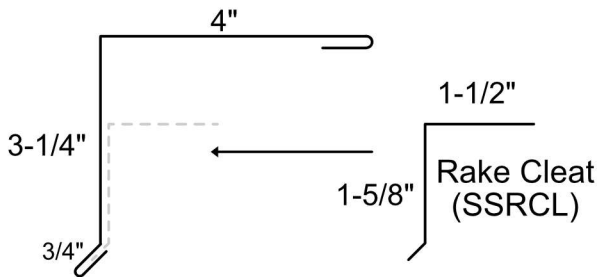

Z-Trim (SSZ)

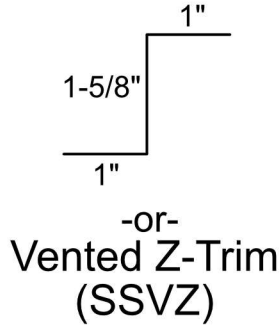

Drip Edge (SSDE)

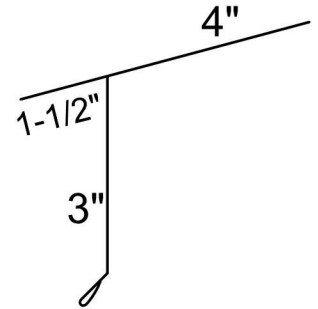

Endwall (SSEW)

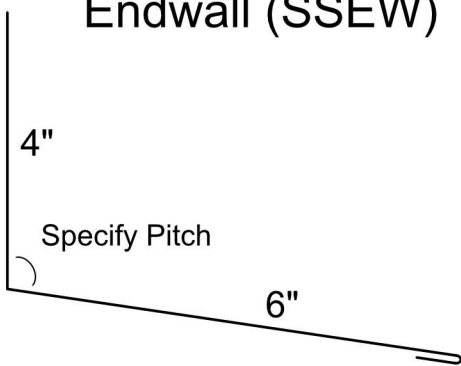

Valley Trim (SSVT)



Sidewall (SSSW)

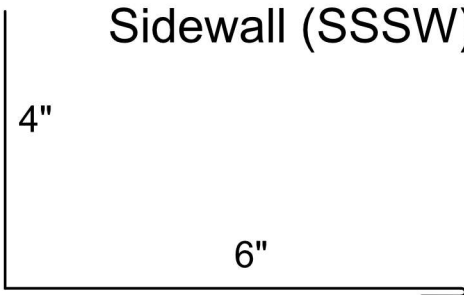

Transition Flashing (SSTF)

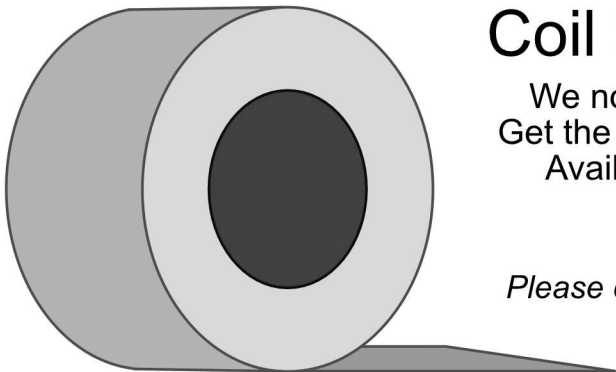

Coil Slitting and Recoiling

We now offer custom slitting and recoiling. Get the exact coil you need, when you need it. Available in any of our colors or gauges, or bring your own!

Packaging and slit fees may apply. Please contact our sales team for more information.

