

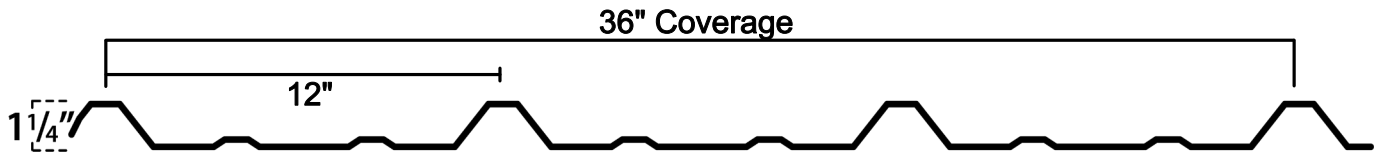

PBR PANEL

INSTALLATION GUIDE

R-Panel



Fastening

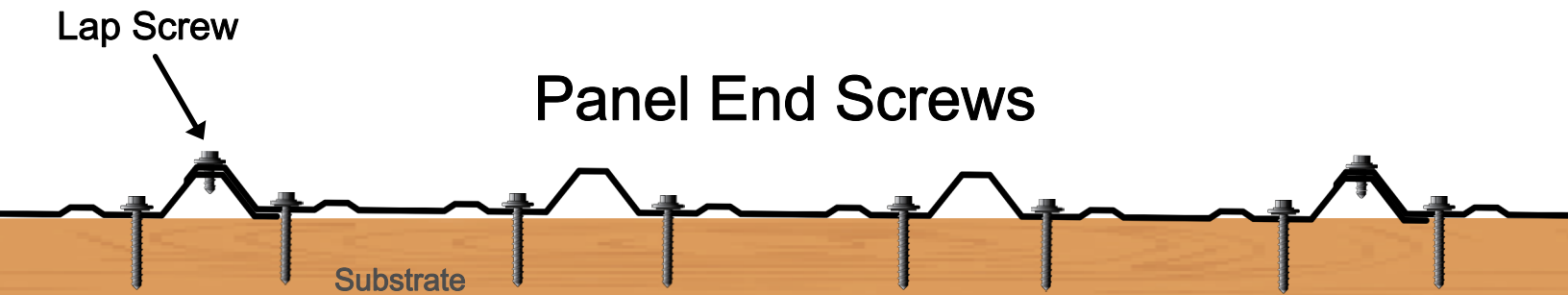
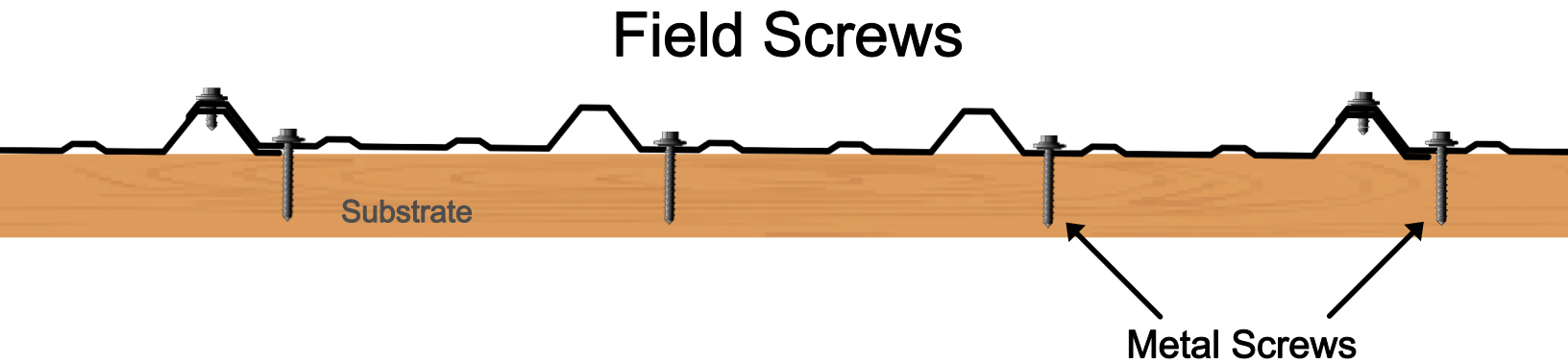

Lap Screws are placed every 2 ft.

R-Panel Specific J-Trim

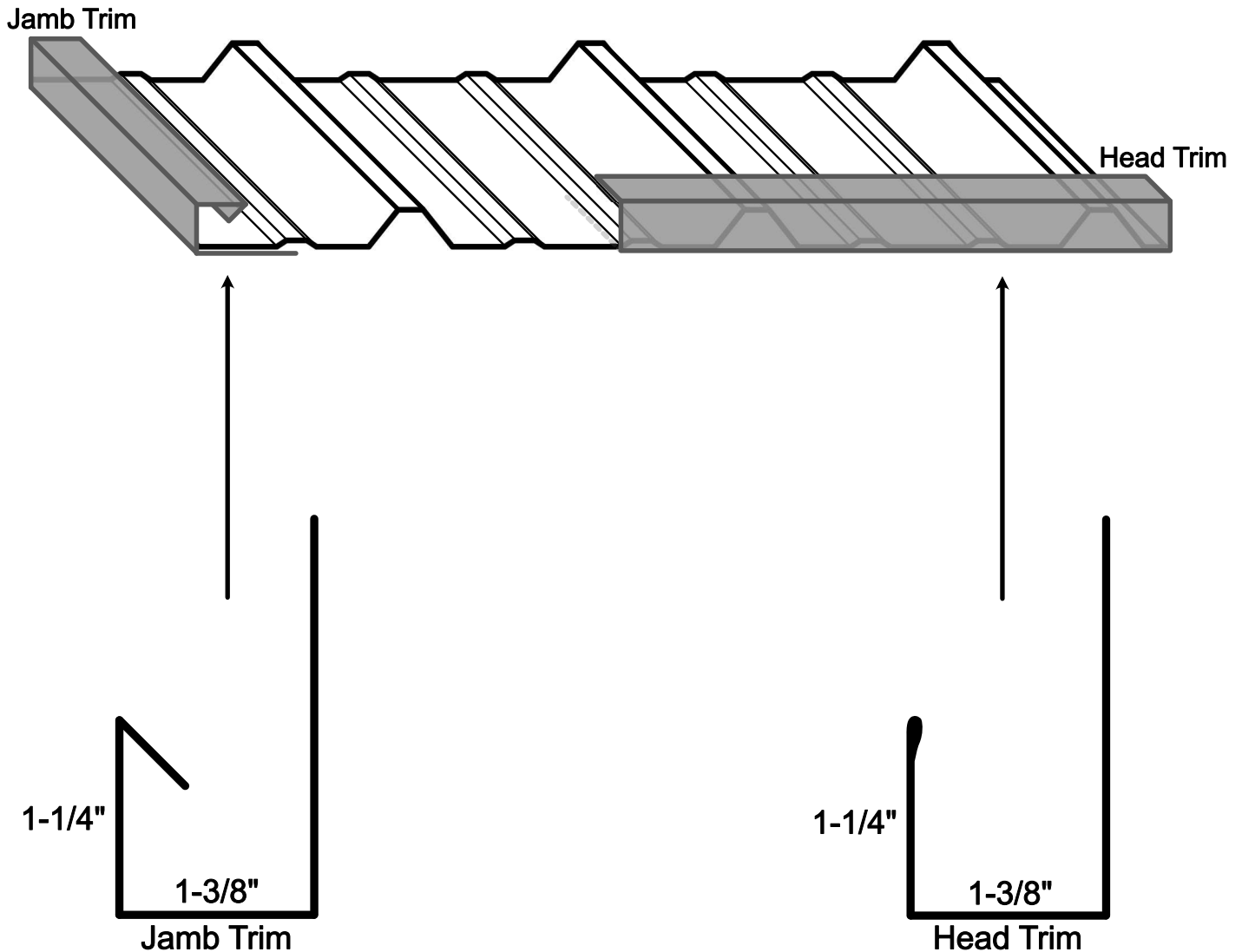

R-Panel Jamb Trim and Head Trim are essentially the same product, but each is designed for a specific installation.

Jamb Trim is made to be installed vertically, running in the same direction as the panel ribs. It is typically used on the sides of doors and windows.

Head Trim is made to be installed horizontally, running across (against) the panel ribs. It is commonly used at the top of walls or above doors and windows.

R-Panel Overhead Door

R-Panel Head Trim
(Top)

-or-

R-Panel Jamb Trim
(Sides)

Steel Frame

2-1/2"

8-1/8"

R-Panel OHD Jamb Cover

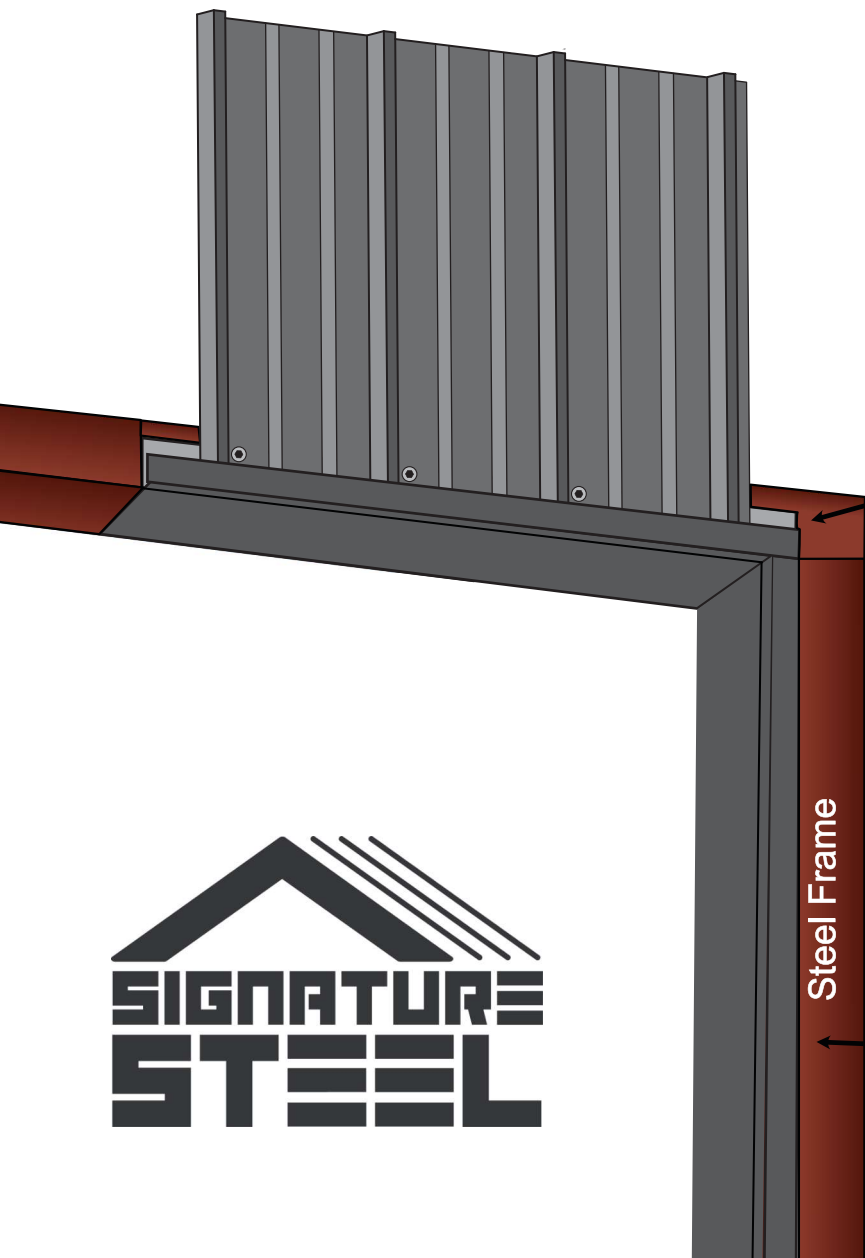

R-Panel Head Trim
(Top)

Steel Frame

R-Panel Jamb Trim
(Sides)



R-Panel Sculpted Rake

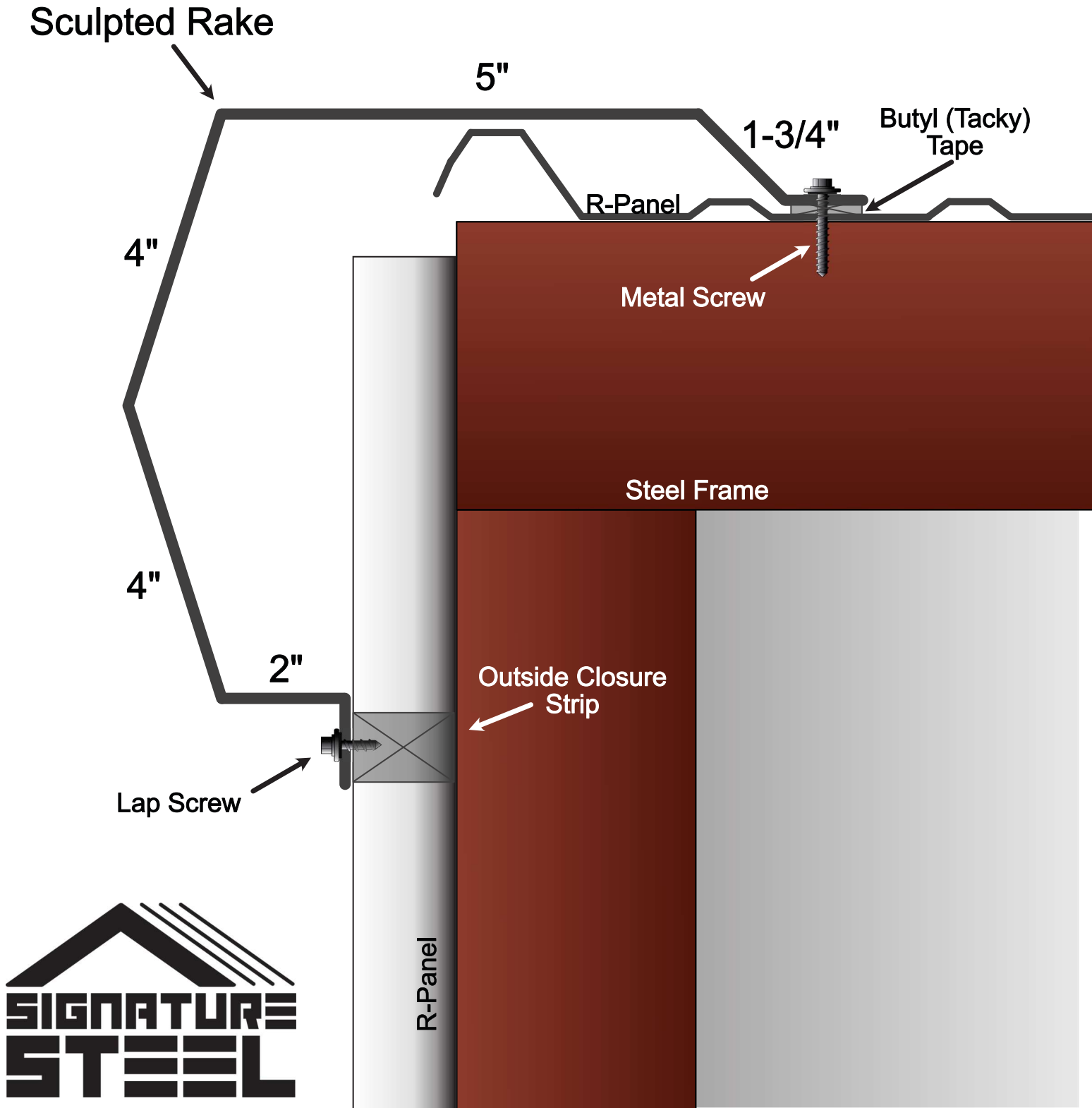

R-Panel Gutter Detail

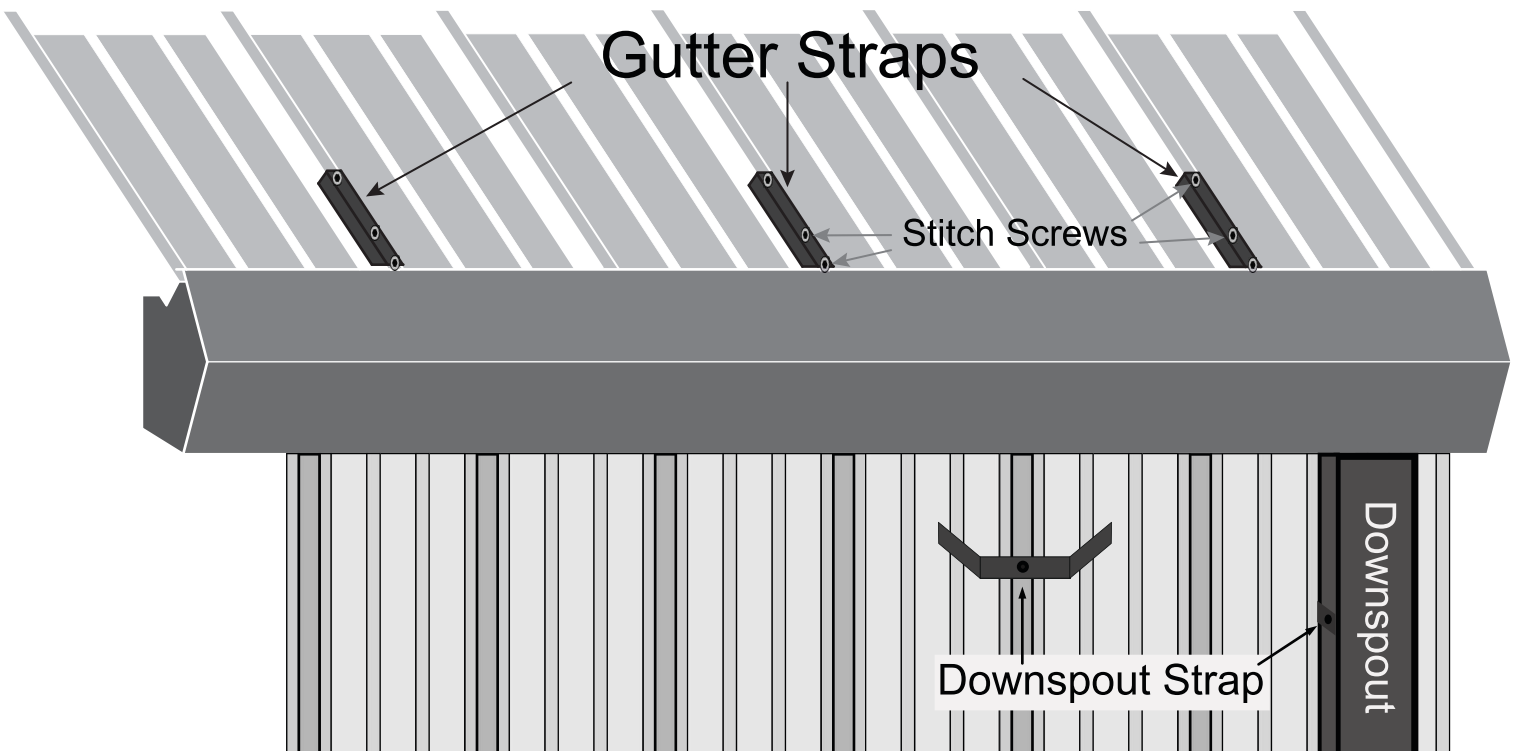
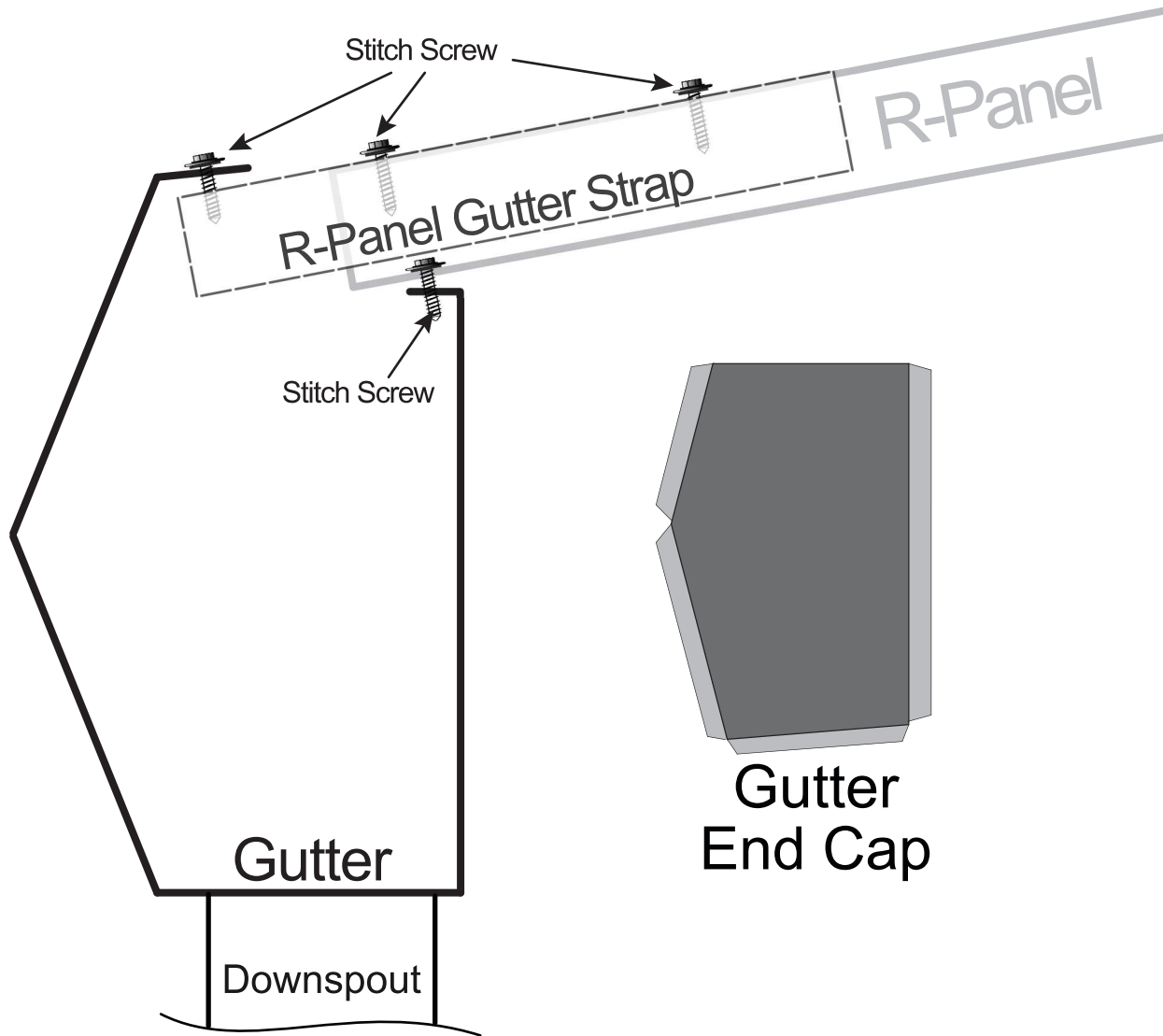

End Caps

Standard Corner
Peak Plate



Field Cut and Bend to Fit

Sculpted Corner
Peak Plate

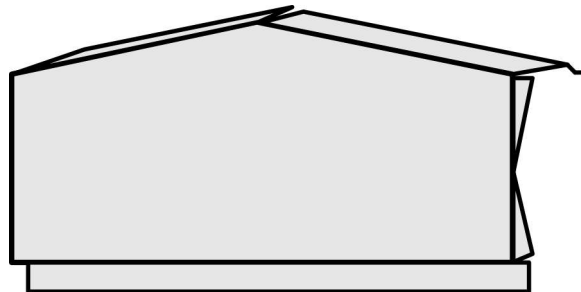

Field Cut to Fit

End caps available for gutters.

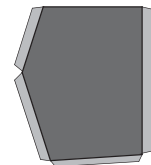

Corner boxes available for sculpted
rake to sculpted gutter applications.

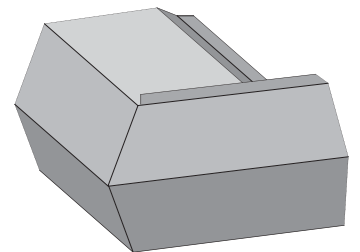

Big Ridge (BR)

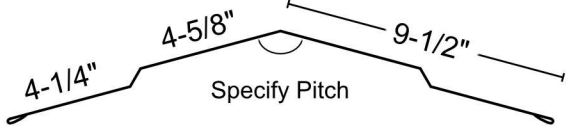

R-Panel Corner (RCOR)

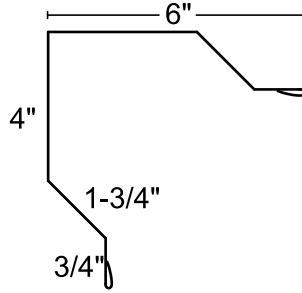

R-Panel Res Rake (RRR)

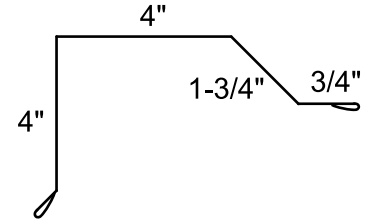

R-Panel Inside Corner (RIC)

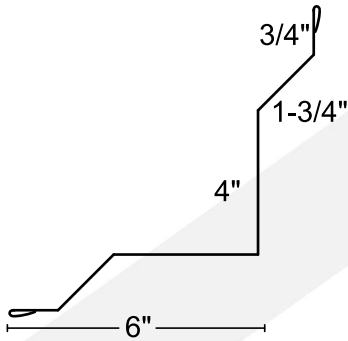

R-Panel Sculpted Rake (RSR)

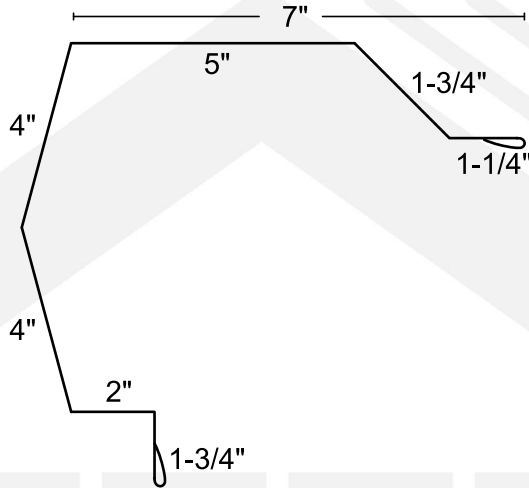

R-Panel Sculpted High Side Eave (RHS)

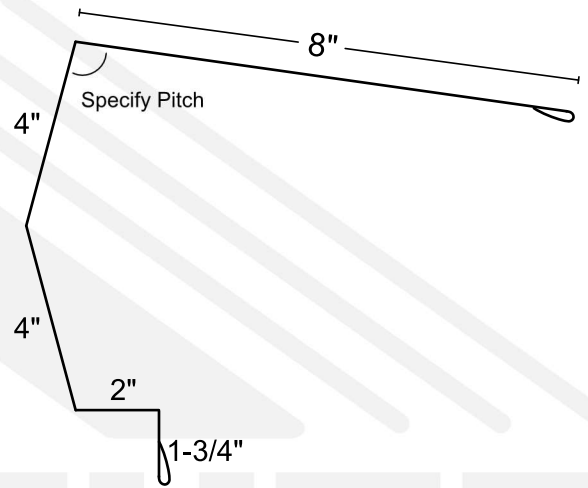

Commercial Open-Hem Valley Trim (RVT)



R-Panel Sidewall (RSW)

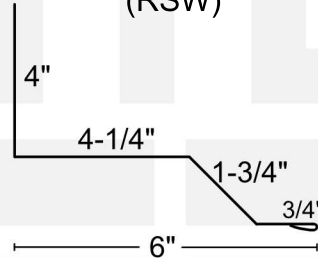

Endwall (EW)

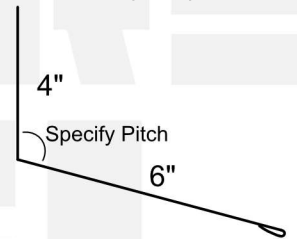

R-Panel Overhead Door Jamb Trim (ROHD)



R-Panel J-Trim

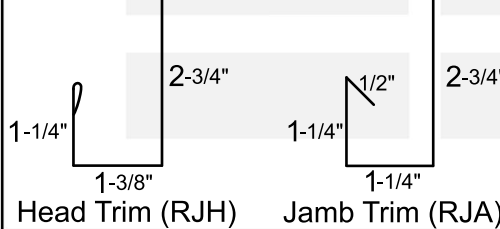

R-Panel Ratguard (RRG)

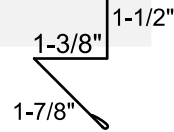

R-Panel Wainscot (RWC)

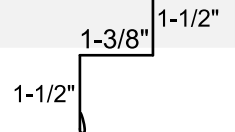

R-Panel Sculpted Gutter (RSR)

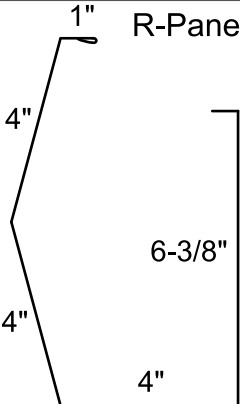

Downspout (RDS)

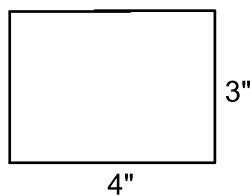

Gutter Strap

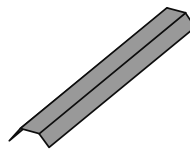

Downspout Strap



Sculpted Peak Box (RPB)

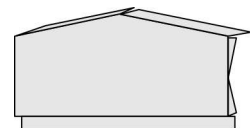

Sculpted Peak Box (RCORBOX)

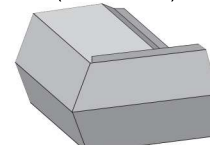

R-Panel Long Eave (RLE)

